



SignatureDOORS

The next generation ALUMINIUM composite door



6 GUARANTEED SECURITY



10 CHOOSE YOUR SIGNATURE STYLE



8 OUTSTANDING PERFORMANCE

The next generation aluminium **COMPOSITE DOOR**

Our British made entrance doors deliver all the great features that homeowners want, without any of the inherent weaknesses of other materials.

Make a great first impression with our Signature Doors which have been designed to complement homes of every description – from very traditional to ultra modern.

The Signature Door range is the result of extensive research and careful design. Having closely examined all the entrance doors currently available and assessed their various strengths and weaknesses, we have developed the next generation

of composite doors. Our British made aluminium entrance doors deliver all the great features that homeowners want, without any of the inherent weaknesses of other materials.

Compared to the alternatives, our Smart Signature Door range delivers; better security, better performance, better looks, and better value.

In this brochure you can find out more about the benefits that our aluminium composite doors deliver. You can also explore the full Signature Door range and all the available colour, glazing and hardware options.

We hope you'll be impressed with what you read. We know you'll be impressed with your new door.



We are proud to be recognised as a British manufacturing success story – and to be a member of the Made in Britain network.

www.madeinbritain.org



32 COLOUR
YOUR DOOR



36 HARDWARE
OPTIONS



38 SURROUNDS
& GLAZING

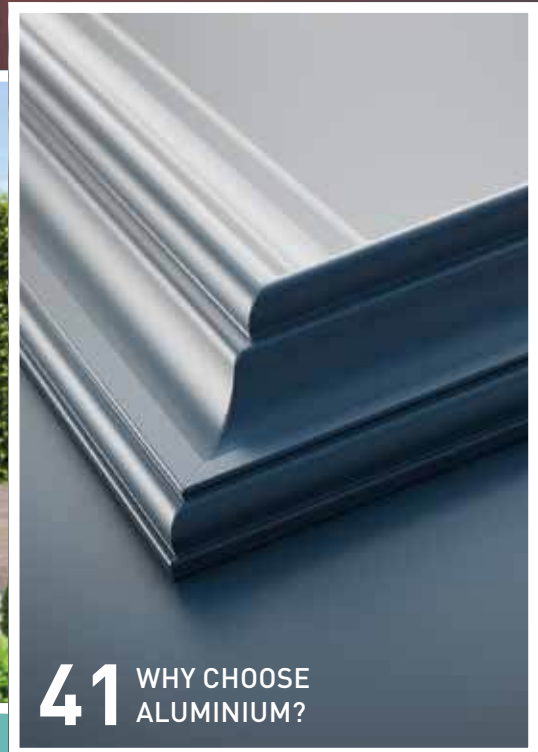

41 WHY CHOOSE
ALUMINIUM?

We've taken traditional composite doors and improved key components by using aluminium

- ✓ **Beautiful aesthetics** – elegant styling suits all types of home.
- ✓ **Lustrous paint finish** – perfectly matched on the door and frame.
- ✓ **Outstanding security** – exceeding all industry standards.
- ✓ **Will not warp and will not fade** – remains just as good as the day it was installed.
- ✓ **Superior weather performance** – with two weather seals, our clever design provides outstanding protection.
- ✓ **Excellent efficiency** – keep your home warm and your energy bills down.
- ✓ **Virtually maintenance free** – simply wipe down to retain its pristine looks.
- ✓ **Unrivalled guarantees** – including our incredible £4,000 lock guarantee.

The perfect finish FOR YOUR DOOR

Our unique textured powder coat paint finish gives every door a stunning, lustrous finish.

The high quality, UV-resistant surface won't fade or crack. With a higher resistance to scratches and scuffs, it will also stand up to the rigours of everyday life, maintaining its fantastic looks for decades to come.

Unlike PVC and GRP composite doors, our doors and their frames are made from exactly the same material and painted in exactly the same way to guarantee a perfect, lasting colour match, every time.

We're proud to offer perfectly matching frames along with your Signature composite door.



Broadfield, Frame: White KI010 Sash: Zinc Yellow CTN006



UNMATCHED *paint guarantee*

Even if your home is exposed to the harshest climate, we guarantee our marine-grade paint finish will maintain its brilliance for up to 25 years, with our Qualicoat approved finishing processes giving you the assurance of the highest quality and protection (unlike most other doors, which only have a 10 year guarantee).

In fact with just an occasional wipe down, your door will look every bit as good in 25 years as it does the day it's installed. You will never need to paint, stain or varnish it.



Carnaby Frame & Sash: Moss Green CTN003

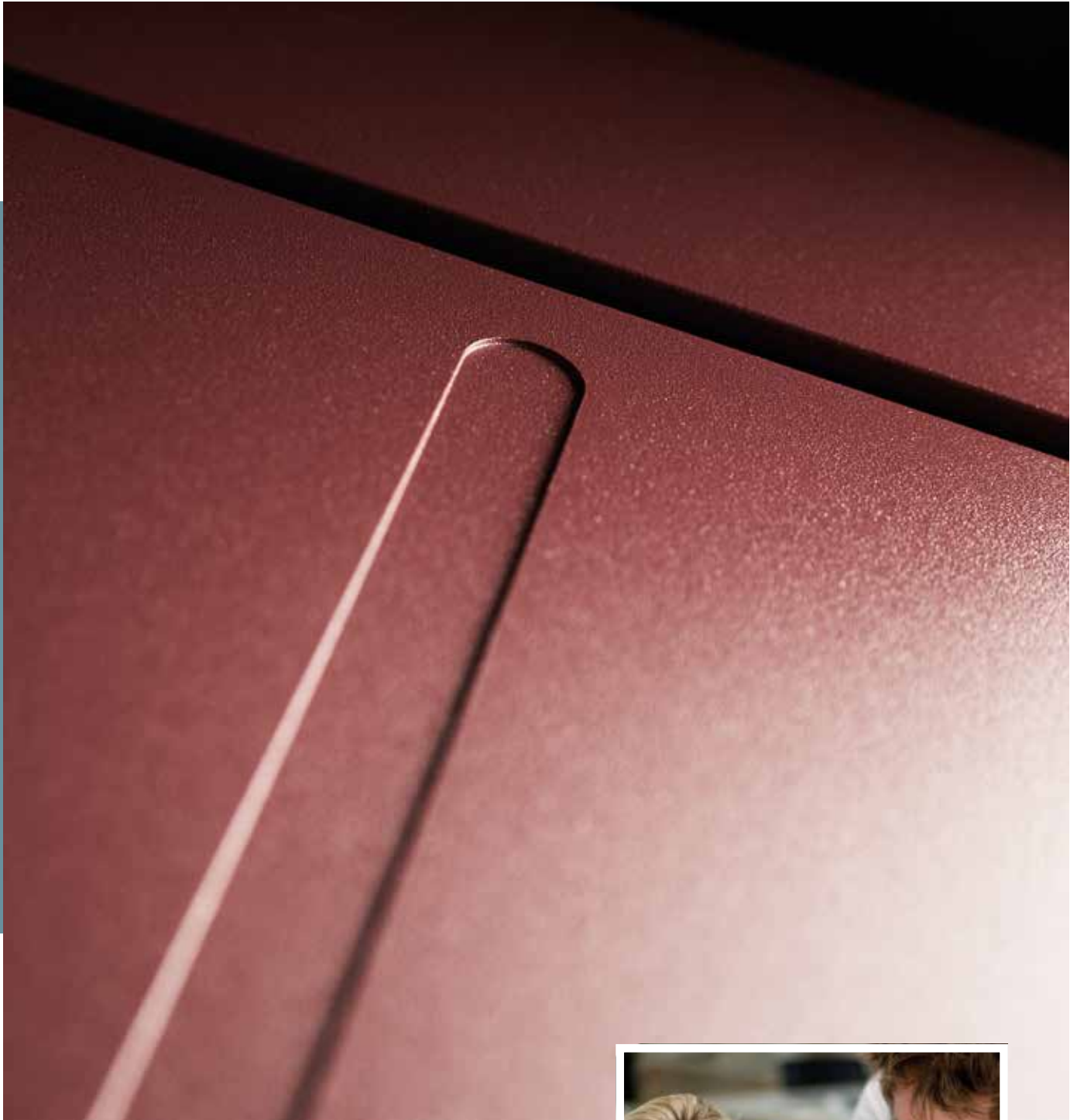

COLOUR YOUR DOOR

The choice is yours

Selecting from our huge range of colours, with almost limitless options, you can choose to have the inside and outside of your door finished in identical, or different colours, as well as the inside and outside of your door frame – and even your accessories.

So, you could have every surface the same colour, or all different – the design choice is entirely yours.



Your home's security IS GUARANTEED

It isn't just style that comes as standard with every Smart Signature Door. Each door also provides outstanding security.

Our attention to detail extends not only to the quality of our doors, but also to the hardware that provides those all-important finishing touches, and the locks that secure them.

With over 80,000 different key combinations, and a choice of locking mechanisms that includes slam lock, hook and deadbolt locks, every Signature Door provides outstanding protection.

Our 3* Kitemarked Euro Cylinder

For extra security, we provide every Signature Door with 3 star cylinders as standard:-



ANTI-SNAP

Even if the lock is snapped, an intruder can't gain access to the lock's inner workings.



ANTI-BUMP

'Bumping' is a process of making the pins jump above the shear line, anti-bump prevents this.



ANTI-PICK

The locks are made in such a way that they are almost impossible to pick.



ANTI-DRILL

Hardened steel anti-drill pins are located at each side of the cylinder.

EXCLUSIVE £4000 SECURITY GUARANTEE

We are so confident in our 3* cylinders that they are backed by a £4,000 guarantee.

This means that if your home gets broken into via one of our 3* cylinders, in the event that an insurance company won't pay out, we are offering a guarantee of up to £4,000 to cover the cost of any stolen goods.

Terms & conditions apply.
See website for further details.

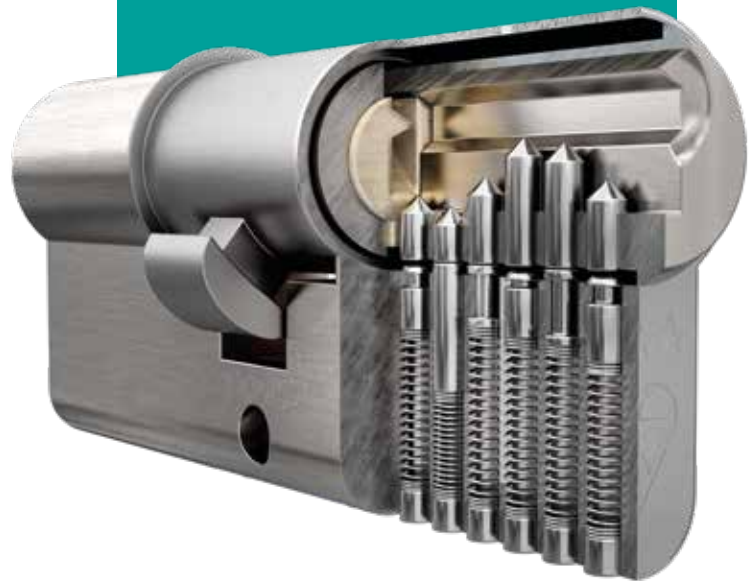

DIAMOND STANDARD cylinder security...

Sold Secure is a British organisation that tests and certifies security products and is trusted by insurance companies, locksmiths and security professionals.

Our cylinders have been awarded the Sold Secure Diamond Standard, and so are among the highest rated and most secure cylinders available. The cylinders are subject to stringent and rigorous testing to ensure they can withstand a wide range of attacks.

Using a Sold Secure Diamond Standard cylinder, you can significantly enhance the protection of your home, with the reassurance that you have invested in a lock that is proven to resist the most determined and skilled intruders.



UNBEATABLE SECURITY FOR YOUR HOME

1. PAS 24

Approved

Fully compliant with the requirements of the industry standard PAS 24, every Signature Door provides outstanding protection, at the heart of which is our 3* cylinder, backed by a £4,000 guarantee.



PAS 24:2022
APPROVED

2. High Security Locking System

All of our locks conform to British Standards version BS3621.

3. 3 Star Cylinder

For complete peace of mind, our 3* Kitemarked Euro cylinder provides guaranteed protection.



4. Security Glazing

All our glazed doors benefit from laminated and toughened, double glazed units that are PAS 24 approved.

5. Strong and Durable Aluminium Panels

All doors are manufactured using 1.5mm aluminium skin as standard.

6. Three Heavy Duty Hinges

Our adjustable door hinges offer long life performance and maintenance free operation. They have low friction bearings for smooth door opening and are fully adjustable in 3 directions. These heavy duty hinges are resistant to 80kg of pressure per hinge.

Lansdown
Frame & Sash Pastel Blue CTN002

APPROVED TO PAS 24 *door security...*

As an assurance of security, all our Signature Doors are tested to PAS 24 (the BSI security standard for doors) and are also able to meet the requirements of Secured by Design.

PAS 24 approval means that the doors meet rigorous standards for protection against forced entry and intrusions, keeping your home safe and secure.

Secured by Design, the UK Police Service's official security initiative approval provides even more reassurance, with your door having met the organisation's requirement for security products that can deter and reduce crime.



PAS 24:2022
APPROVED

Secured by Design



Official Police Security Initiative



Carnaby, **Frame & Sash**: Textured Anthracite Grey KL14ST

Outstanding performance FOR EVERY HOME

Aesthetics

Our range has been designed to provide a collection of stylish and elegant entrance doors that will complement any home.

Finish

Our marine grade powder coat finish is simply the best there is. Our doors won't crack or fade, nor will our doors warp. Unlike other materials, your aluminium door will look as good in 20 years as it does on the day it's installed'.

Guarantee

So confident are we that our doors will deliver decades of trouble-free performance that we guarantee every aspect of them – from manufacture, paint finish, and glazing, to hardware and security. No other manufacture offers our levels of reassurance for your home

Security

Achieving the requirements of the BSI security standard PAS 24, every Signature Door provides outstanding protection, at the heart of which is our 3* cylinder, backed by a £4,000 guarantee.

HELPING REDUCE *your energy bills*

Did you know that homes lose 10-20% of their heat through windows and external doors?

With Smart's Signature Doors you'll notice the difference in temperature, comfort and overall atmosphere of your home. With excellent insulation, our doors also incorporate a polyamide thermal barrier offering U values of 1.2 – 1.4 W/m²K* and two weather seals, providing enhanced thermal performance for your home – saving energy and money.

*Dependent on design

Broadfield, **Frame & Sash**: Ruby Red CTN005



Our Doors Are 36% Thicker

than GRP (Glass Reinforced Plastic), composite doors

With a thickness of 60mm (compared to 44mm for GRP composite doors) our aluminium composite door leafs provide superior strength and security. They present a powerful visual and physical deterrent to potential intruders.

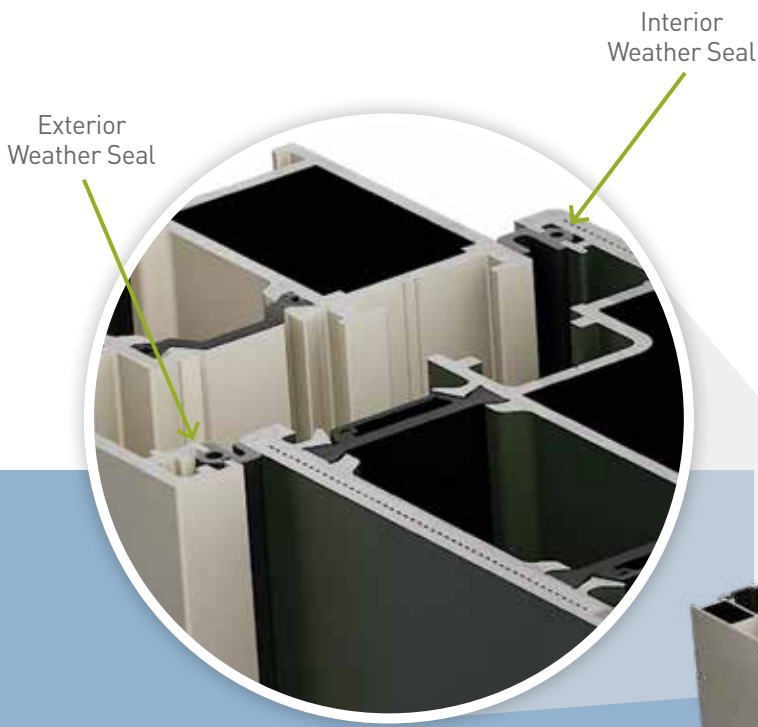

CLASS LEADING WEATHER SEALS

All our doors are finished with two separate weather seals – one inside and one outside – providing superior weather protection as standard.

Our Signature Doors have also been designed with a 'thermal break', which effectively helps prevent cold air from outside coming into your home, and the warmth from inside escaping.

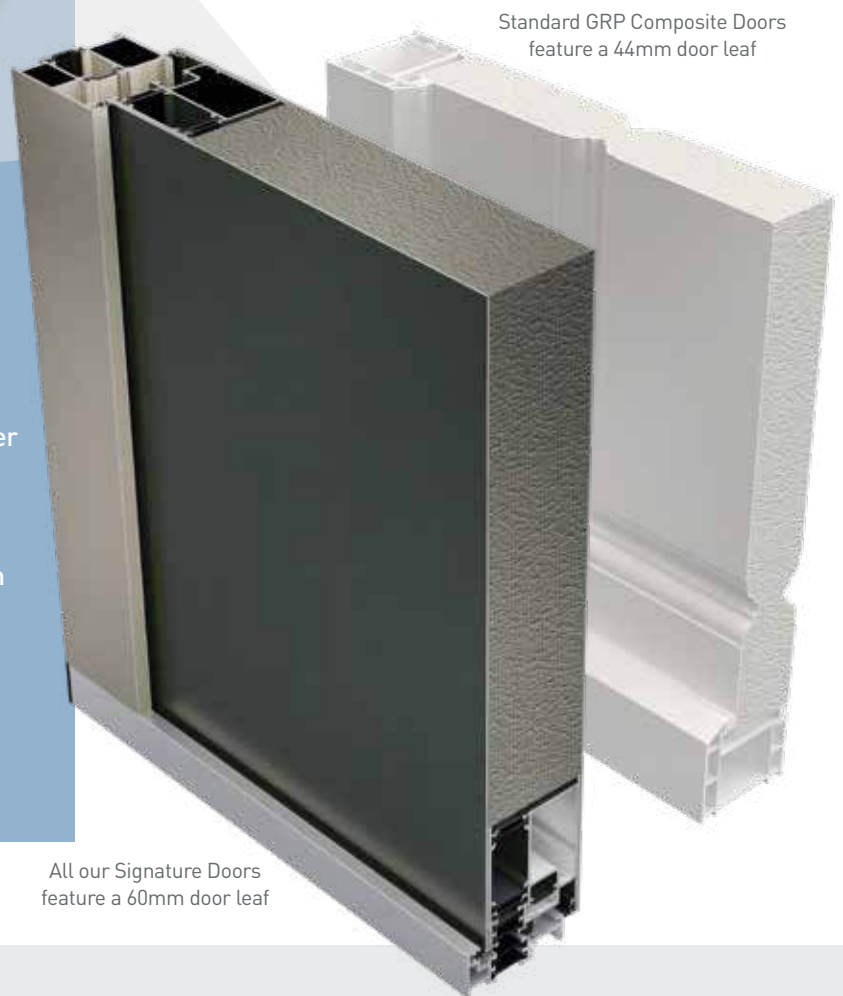

All our Signature Doors feature a 60mm door leaf

Standard GRP Composite Doors feature a 44mm door leaf

KEEP THE WEATHER *and noise out*

All our doors feature the added assurance of two weather seals, which provides superior weather protection to keep your home warm and energy bills down.

With U-values of 1.4 or better, our doors provide excellent insulation so you and your family will stay warm and comfortable, whatever the weather outside. Signature Doors also provide effective noise reduction to improve the all round comfort of your home.

Woodchester, Frame & Sash: Zinc Yellow CTN006



HARLEY



This classic design works perfectly with traditional and modern properties alike.



Frame: White KL010
Sash: Textured Black KL15ST



Frame: Sapphire Blue CTN001
Sash: Steel Blue SEN028



Frame: White KL010
Sash: Ruby Red CTN005



Frame & Sash:
Platinum Grey SEN016

NEW HERITAGE SLAM LOCK

To enhance a traditional, classic appearance, we have added a new Heritage slam lock to our collection of hardware.

Shown here featuring a finger pull, the new lock will be located in a traditional position; typically two thirds of the way up the door.

The new Heritage slam lock option is available on all styles in the range and also works with our range of escutcheons.



Frame & Sash: Moss Green CTN004



New Finger Pull



Frame & Sash: Sapphire Blue CTN001



KEY SECURITY FEATURES

- Every door comes complete with a 3* Kitemarked Euro Cylinder lock as standard.
- Each lock has more than 80,000 different key combinations; in a range that includes slam, hook and deadbolt locks.
- Signature Doors are BSI Kitemarked, comply with PAS 24 (the BSI security standard for doors), and are able to meet the requirements of Secure by Design.

Frame & Sash: Frost White SEN022



CARNABY



This modern design brings contemporary style to any home.



Frame & Sash:
Textured Anthracite KL14ST



Frame & Sash:
Cotswold Green CWD012



Frame & Sash:
Sand SEN003



Frame: White KL010
Sash: Sky Blue SEN009

CHOOSE YOUR COLOUR

Whether you want your door, frame and accessories to perfectly match or boldly contrast, we have a huge range of colours to achieve your perfect design. The inside and outside of your door can be finished in the same or different colours, as can the inside and outside of your door frame.

So, you could select all four elements perfectly matched, or subtly (or strikingly) different. The choice is yours.



Frame: White KL010
Sash: Zinc Yellow CTN006



RAL Colour Chart



Frame & Sash: Textured Black KL15ST



KEY COLOUR FEATURES

- With an aluminium door frame, door leaf and skin, all the elements of your Signature door work in perfect harmony and are matched to perfection.
- Our paint finish is backed by an unbeatable 25 year guarantee.
- The marine-grade paint finish provides a robust, resilient and long-lasting finish to your door.

Frame & Sash: Silver Grey SEN017



LANSDOWN



Three glazed panels add an interesting design twist to this stylish, modern door.



Frame: White KL010
Sash: Moss Green CTN004



Frame & Sash: Textured Anthracite Grey KL14ST



Frame: Sienna Brown SEN004
Sash: Slad Stone CWD015



Frame: White KL009 (WP)
Sash: Melon Yellow CTN007

CHOOSE YOUR LOCK

Our range of locks and accessories allows you to personalise your Signature Door, to meet your requirements, providing those all-important details to complete the aesthetics and security of your home.

With over 80,000 different key combinations and a choice of locking mechanisms every Signature Door provides outstanding protection. Backed by a £4,000 guarantee, we provide 3* cylinders as standard across our entire range.

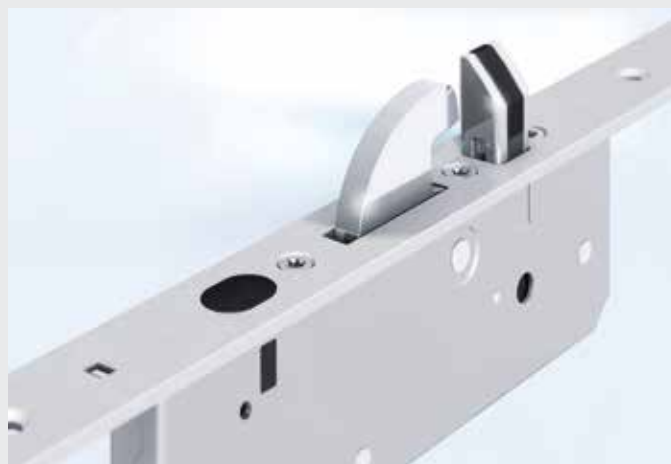



Frame: White KL010 Sash: Steel Blue SEN028



KEY LOCK FEATURES

- 3* Cylinders fitted to all doors – complete with £4,000 guarantee.
- Choice of five high security locks.
- Double glazed, 6.8mm laminated glass fitted as standard.

Frame & Sash: Gold Pearl ALC003



MILLBROOK



A timeless classic, this solid entrance door oozes understated elegance and style.



Frame & Sash:
Basque Red SEN032



Frame & Sash:
Bourton Cream CWD002



Frame: White KL010
Sash: Pastel Blue CTN002



Frame: Black KL008 (BL)
Sash: Melon Yellow CTN007

LONG PULL HANDLES

The choice of hardware for your door is an important one as it not only affects the door's appearance, but also how you operate it (opening and closing, locking and unlocking).

If you are looking for a modern look and feel, our round long pull handles are a great option. We have now added black as a standard colour finish across the range as well as a new square handle option. When using a single long pull handle, invisible fixings provide an elegant and stylist aesthetic to any door.



Round and Square Long Pull Handles



Stylish Invisible Fixings



Frame & Sash: White KL010



KEY FINISHING FEATURES

- With invisible fixings, our stainless steel long pull handles provide a sleek and modern finishing touch. Standard options include black finish, and a choice of round or square profiles.
- Any item of stainless steel hardware that is fitted to your door is fully guaranteed for 15 years.

Frame & Sash: Platinum Grey SEN016



PORTOBELLO



Impressively modern, with two glazed options, this design brings contemporary style to the Signature range.



Frame & Sash: Melon Yellow CTN007



Frame: White KL010
Sash: Steel Blue SEN028



Frame: Black KL008 (BL)
Sash: Platinum Grey SEN016



Frame: White KL010
Sash: Ruby Red CTN005

CHOOSE YOUR GLAZING

Your choice of glazing will play a major part in the overall design of your door and will obviously affect how much light comes through your door, and any top or side lights, and into your home.

Clear or satin units are standard, however, our doors can also be supplied unglazed, to allow you to select your own, bespoke glass designs. Your installer will be happy to discuss the options and help you make the right choice for your home.





Frame & Sash: Textured Anthracite KL14ST



KEY GLAZING FEATURES

- Double glazed, 6.8mm laminated glass units are fitted as standard.
- Choose either clear or satin finish glazing units.
- Signature doors can be supplied fully glazed, or unglazed, enabling you to select your own, bespoke glass designs.

Frame & Sash: Sand SEN003



BROADFIELD



The traditional Broadfield design brings a perfect country cottage look to any home.



Frame: White KL010
Sash: Ruby Red CTN005



Frame: Sienna Brown SEN004
Sash: Bourton Cream CWD002



Frame: White KL010
Sash: Wotton Olive CWD010



Frame & Sash:
Mint Green CTN003

CHOOSE YOUR ACCESSORIES

We offer a wide choice of letter plates, handles and knockers in a range of colours, styles and materials – including stainless steel and chrome.

With coordinating collections ranging from modern to traditional designs, the choice of door accessories will both complete the look of your new door and provide all the functions you require.

Lansdown, Frame & Sash: Painswick Stone CWD008





Frame: White KL010 Sash: Zinc Yellow CTN006



KEY FINISHING FEATURES

- Extensive range of styles, materials and finishes.
- Includes handles, letterplates, knockers and spy holes.
- Design styles span from contemporary to traditional.

Frame & Sash: Cheltenham Stone CWD005



ABBEY



The striking Abbey door, with three glazing options, offers outstanding design flexibility.



Frame & Sash:
Silver Grey SEN017



Frame & Sash:
White KL010



Frame & Sash:
Sky Blue SEN009



Frame: Bilbury Stream CWD003
Sash: Painswick Stone CWD008

CHOOSE YOUR COLOUR

The number of colour combinations from our extensive ranges are almost limitless. You can select from our own carefully curated ranges of textured colours, or choose almost any RAL colour.

Whichever combination you decide on, you can be assured that the quality of finish will be second to none, with your door, frame and accessories all perfectly matched (if that's what you choose) to provide you with decades of fade-free, hard wearing service.



Sash: Antique Green SEN012



Smart Colour Guide



Frame & Sash: Velour White SEN001



KEY COLOUR FEATURES

- Our marine grade powder coat finish gives your door a lustrous, long-lasting finish.
- All powder coating is done in house so your aluminium door, frame and components will perfectly match.
- Our marine grade powder coated finishes are all backed by an unrivalled 25 year guarantee.

Frame & Sash: Zinc Yellow CTN006





Frame & Sash: Diamond Grey SEN026

WOODCHESTER



This stylish door makes a beautiful front or back entrance allowing natural light into your home.



Frame & Sash:
Velour White SEN001



Frame: White KL010
Sash: Basque Red SEN032



Frame & Sash:
Cheltenham Stone CWD005

CHOOSE YOUR CYLINDER

Our 3*, Kitemarked Euro Cylinder range includes two main cylinder types; key/key or thumb turn cylinders.

Our anti-burglar guarantee means that if your home gets broken into via the cylinder, and your insurance company won't pay out – we will pay up to £4,000 to cover the cost of stolen goods.



ANTI-SNAP



ANTI-BUMP



ANTI-PICK



ANTI-DRILL



Thumb Turn Cylinder



Key/Key Cylinder



Frame & Sash: Cotswold Green CWD012



KEY SECURITY FEATURES

- All our doors meet the requirements of PAS 24, the industry's security standard.
- Providing outstanding security, 3* cylinder are fitted as standard to all our doors.
- Manufactured from high-strength aluminium, our doors provide a visible deterrent.

Frame & Sash: Traffic Purple RAL 4006





Frame & Sash: Velour White SEN001

BAKER



This stylish panelled door works equally well as a front or back door, letting light flood in to any space.



Frame & Sash:
Steel Blue SEN028



Frame & Sash:
Wootton Olive CWD010



Frame & Sash:
Pastel Violet RAL 4009

CHOOSE YOUR ACCESSORIES

Our range of high-quality accessories has been carefully curated to complement the look, quality and performance of your new Signature Door.

With all the options suited to perfectly match each other, we have a wide choice of letter plates, handles and knockers in a choice of colours, styles and materials, including stainless steel and chrome.

Harley Frame & Sash: Textured Black KL15ST





Frame & Sash: White KL010



KEY FINISHING FEATURES

- Suited range in a choice of materials – including stainless steel and chrome.
- Wide range of handle designs for internal and external use.
- Colour matched hinges available.

Frame & Sash: Westonbirt Leaf CWD014





Frame & Sash: Textured Anthracite KL14ST

PICTON



With its contemporary, chic design, our Picton door adds a real sense of style to any property.



Frame & Sash:
Basque Red SEN032



Frame & Sash:
Silver Grey SEN017



Frame & Sash:
Black KL008 (BL)

CHOOSE YOUR COLOUR

UV resistant and guaranteed not to fade or crack, Signature Doors will retain their beautiful finish for years to come.

And as the doors and frames are made from the same material and painted in the same way, if you choose to have them in the same colour, it will be a perfect match.

Harley Frame & Sash: Textured Black KL15ST

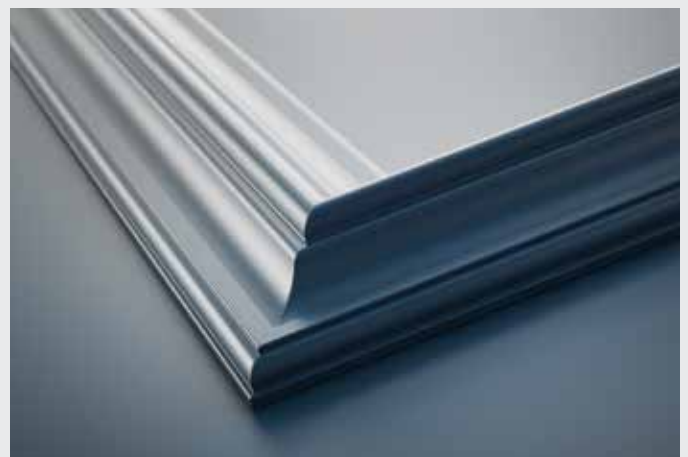



Frame: Anthracite Grey KL005 Sash: Agate Grey KL017



KEY COLOUR FEATURES

- All the elements of your Signature door work in perfect harmony and are matched to perfection.
- The marine grade powder coat finish provides a robust, resilient and long-lasting finish to your door.
- Our marine grade powder coat finish is backed by an unbeatable 25 year guarantee.

Frame & Sash: Gold Pearl ALC003





Frame & Sash: Diamond Grey SEN026

GRAINGER



The Grainger's distinctive horizontal and vertical design lines create a stylish, modern aesthetic for houses and apartments alike.



Frame & Sash:
Pastel Blue CTN002



Frame: White KL010
Sash: Cotswold Green CWD012



Frame: White KL010
Sash: Slad Stone CWD015

SECURITY IS GUARANTEED

Our anti-burglar guarantee means that if your home is broken into via the cylinder, and your insurance company won't pay out – we will pay up to £4,000 to cover the cost of stolen goods.

As well as our doors and locking mechanisms, our double glazed units are also approved to the PAS 24 security standard, and feature laminated and toughened glass.





Frame & Sash: Melon Yellow CTN007



KEY SECURITY FEATURES

- 3* Cylinders fitted to all doors – complete with £4,000 guarantee.
- Choice of five high security locks.
- Double glazed, 6.8mm laminated glass fitted as standard.

Frame & Sash: Mint Green CTN003



Make it yours COLOUR

Why not take inspiration from the selected range of our 24 most popular colours (you can find colour swatches in the fold out section at the back of the brochure).

Once you have chosen your colours, you can be assured of a lustrous high quality finish that won't fade or crack, and will stand up to the rigours of everyday life.

Unlike other composite doors, our Signature doors and their frames are made from exactly the same material and finished in exactly the same way

to guarantee a perfect, long lasting colour match, every time. PVC and GRP composite doors and frames are made with different materials, meaning the colour doesn't exactly match.

Harley Textured Black KL15ST



Carnaby Silver Grey SEN017

Broadfield Ultramarine Blue RAL 5002



Woodchester Zinc Yellow CTN006

Choose the PERFECT FINISH

Once you have chosen your colour, you can also select your finish.



TEXTURED – Available on Smart's Creations, Sensations, Cotswold and selected Naturals colours.

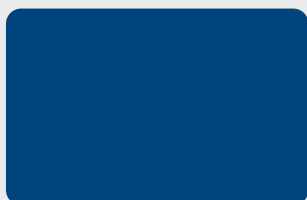

MATT – A smooth, flatter finish creates a classy, timeless surface with a 30% gloss sheen.



COLOUR YOUR DOOR

What are my options?



Choose Your Door Colour

Choose the perfect colour combinations for your door and frame to suit your home's colour schemes. Complement or contrast with your existing colour palette.

You can choose your perfect door colour (or colours), with the same on the inside and outside of your door, or two different colours – the choice is entirely yours.

Your Door

Choose from a textured or matt finish, with the option to match the colour on both sides of your door or a combination inside and out.

Inset Image: **Frame:** White KL010
Sash: Steel Blue



Choose the Colour of Your Hinges

You can choose to match the colour of your door's hinges to the door or frame – or you can choose our matt chrome, black or white finish.

Choose Your Frame Colour

Again you can choose to have the same colour on both sides of the frame, or different ones. And you can choose to match the colour (or colours) of your door; if you do, it will be a perfect match.

Lansdown **Frame & Sash:** Steel Blue SEN028



An unrivalled choice OF COLOURS

If the colours in our 'Top 24' collection aren't quite right for you, sitting behind them is a wide range of options.

Choose from our own specially curated collections, please see our 'Guide to Creative Colours & Finishes' for more details. We can also powder coat your door to many of the industry standard RAL colours available – just ask us to see if a particular RAL colour is available.

Millbrook **Frame & Sash:** Antique Pink RAL 3014





Make it yours LOCKS

Our locks fully comply with the requirements of the industry's security standard, PAS 24, with a choice of five different options available for you to choose from.



Choose the Right Locking System for Your Door

We offer five secure and reliable locking options to suit your needs. Do you prefer a slam lock that locks automatically when shut, or a key lock that requires a key to lock and unlock?

KEY LOCK OPTIONS (Manually Locked with a Key)

- **Two Hook, Two Roller**
High security lock with two hooks and a deadbolt with 2 rollers for compression.
- **Two Hook, Four Deadbolts**
High security lock with two hooks and a deadbolt with an additional four deadbolts.
- **Two Hook, Two Roller (Split Spindle)**
High security lock with two hooks and a deadbolt with two rollers for compression. Generally used for front doors only, the split spindle operation will always require a key to gain access from the outside.



SLAM LOCK OPTIONS (Locks Automatically When Shut)

- **Slam Lock**
Two hooks and a deadbolt. Hooks throw automatically as the door is closed. Lock positioned halfway up the door.
- **Heritage Slam Lock**
Two hooks and a deadbolt. Hooks throw automatically as the door is closed. Lock positioned two-thirds up the door.



All our locks achieve PAS 24:2022 & Secured By Design



TESTED 200,000 TIMES for assured performance

For assured reliability, all five of our lock options have each been subjected to a rigorous test regime.

As part of this programme, they undergo 'cyclic testing', which means they are repeatedly locked and unlocked – 200,000 times. That's the equivalent of a family of four each locking and unlocking the door twice a day, every day for 35 years!



Millbrook Frame & Sash: Platinum Grey SEN016

EXCEPTIONAL SECURITY FOR YOUR HOME

Our 3*, Kitemarked Euro Cylinder range includes two main cylinder types. Each provides the same exceptional standards of security and protection for your home.

The options available include the more traditional key/key cylinders, which are operated by a key on both sides of the door, and 'thumb turn' cylinders which are operated by a key on the outside, but by a simple thumb turn on the inside.

Choose from

THUMB TURN CYLINDERS

This type of cylinder is increasingly popular, largely due to its ease of use and convenience. Although a key is required to lock or unlock the door from the outside of the house, a simple clockwise turn of the knob locks the door, and an anticlockwise turn unlocks it.

Thumb turn cylinders may be used on all five of our lock options, including slam locks.



KEY / KEY CYLINDERS

As the name suggests, for these cylinders the key is required to lock and to unlock the door, both from the inside and outside of the house. This option is also suitable for all five of our lock types.

So confident are we in the locks' quality and performance, that if your home is broken into via one of our 3* Kitemarked Euro Cylinders, and your insurance company won't pay out, we will pay up to £4,000 to cover the cost of stolen goods.



DO YOU KNOW?

MULTIPOINT LOCK

Smooth operator...

Take up the option of our two-hook, two-roller multipoint lock and you'll get a very smooth operator!

Not only do the lock's roller cams ensure that the door is compressed correctly to give the perfect weather seal, but they also make closing your door easier by gliding everything into place.





Make it yours ACCESSORIES

Select the perfect accessories to provide the all-important finishing touches to your new front and back doors.

Our high-quality range has been carefully curated to complement the look, quality and performance of your new Signature Door. Spanning from modern to traditional designs, and with all the accessories designed to perfectly match each other, we have a wide choice of letter plates, handles and knockers in a choice of colours, styles and materials, including stainless steel and chrome.

Ergonomic Lever Handle and Escutcheon in Matt Black

SLAM LOCK ACCESSORIES

We have assembled a range of high-quality stainless steel accessories specifically to accompany doors fitted with the slam lock option.

ESCUTCHEON

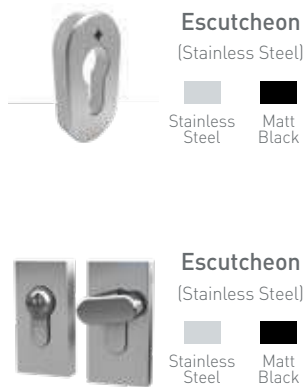

LONG PULL HANDLES

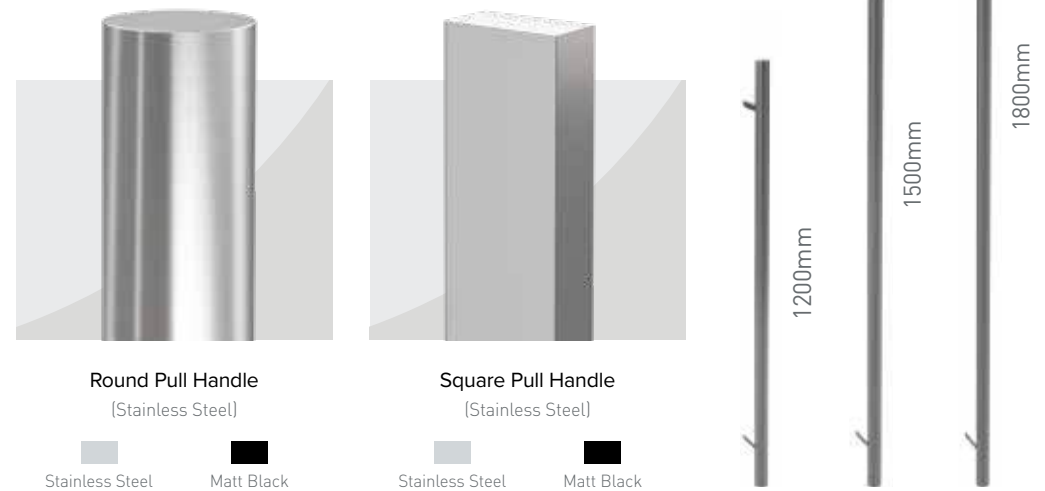

HANDLES & LETTER PLATES



EXTERNAL / INTERNAL HANDLES



Balmoral Inline Lever Handle

(Chrome)



B Chr G Gra W



Windsor Inline Lever Handle

(Chrome)



B Chr G Gra W



Architectural Inline Lever Handle

(Chrome)



B Chr G Gra W



Balmoral Pad Lever Handle

(Chrome)



B Chr G Gra W



Windsor Pad Lever Handle

(Chrome)



B Chr G Gra W

LETTER PLATES



Nu Mail Letterplate

(Chrome)



B Chr G Gra W



Architectural Letterplate

(Chrome)



B Chr G Gra

DOOR KNOBS



Decorative Door Knob

(Chrome)



B Chr G Gra

KNOCKERS



Bull Ring Door Knocker

(Chrome)



B Chr G Gra



Nu Victorian Urn Medium

(Chrome)



B Chr G Gra W



Nu Victorian Urn Medium with Spyhole

(Chrome)



B Chr G Gra W



Nu Victorian Urn Slim Large

(Chrome)



B Chr G Gra W



Nu Victorian Urn Slim Large with Spyhole

(Chrome)



B Chr G Gra W



Architectural Door Knocker

(Chrome)



B Chr G Gra

ESCUTCHEON

FINGERPULL

SPYHOLE



Escutcheon

(Chrome)



B Chr G Gra W



Fingerpull

(Chrome)



B Chr G Gra W



Spyhole

(Chrome)



Chr Brass

Make it yours SURROUNDS

Let light flood into your home with the addition of a glazed door surround. Choose from our range of half-and full-height side lights, together with full width top lights to create a beautiful entrance and a light and airy interior for your home. Double glazed with 6.8mm laminated glass, side and top lights are available in a clear or satin finish.

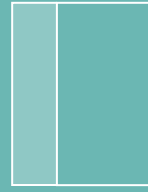

Side Light
Left



Side Light
Right



Side Light
Both sides



Half Side Light
Left



Half Side Light
Right



Half Side Light
Both sides



Top Light

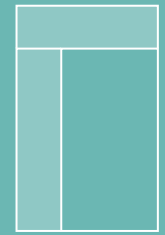

Top & Side Light
Left or right



Millbrook Frame & Sash: White KL010



Why not colour match YOUR DOOR'S FRAME?

Your aluminium door and frame can be perfectly colour matched, with the polyester paint process providing an exact match, every time.

The colour combinations you can select are almost infinite. You can choose to have the inside and outside of your door finished in identical, or different colours, as well as the inside and outside of your door frame.

Broadfield Frame & Sash: Dark Red KL002





Harley Frame White KL010 Sash: Moss Green CTN004

Make it yours GLAZING

Our clear or satin finish double glazed units let light into your entrance or hallway, without compromising the safety or security of your Signature Door.



Clear finish

Satin finish

Harley Frame & Sash:
Platinum Grey SEN016

GLAZING *options*

Our doors can be supplied fully glazed, or unglazed, to allow you to select your own, bespoke glass designs. If you would like to take this option, we recommend you talk to your installer to discuss your choices.



Lansdown Frame & Sash: Steel Blue SEN028



Your Free Maintenance Guide

Free with your new door or visit our website to download a copy.

Now it's yours MAINTENANCE

Our aluminium composite doors are the ultimate when it comes to low maintenance.

To keep your Signature Door looking as new, every three months simply wash it with warm soapy water, using a non-alkaline liquid detergent and a non-abrasive cloth or sponge. Rinse thoroughly with clean water and then dry using a soft cloth. Then every six months, simply lightly oil the door's moving parts

(hinges, handles, hooks, deadbolts etc). That really is all there is to it.

You'll never have to re-paint, re-varnish or treat your aluminium door. The finish of your door and frame will stay exactly as you specified, looking fantastic for decades to come. That's our guarantee.

All you need:



Soft cloth



Light detergent



Fresh water



Polishing cloth

MATT BLACK *stainless steel*

Smart have introduced a matt black finish option for the accessories in the stainless-steel range.

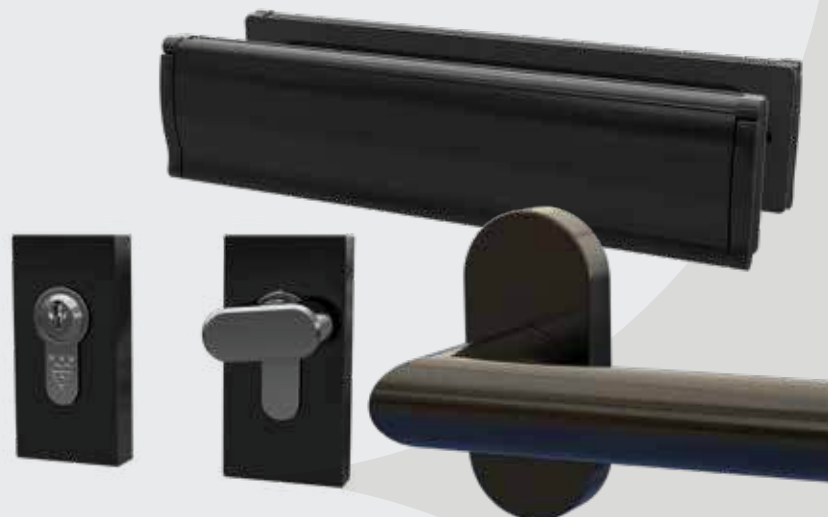







WHY SHOULD YOU BUY A SIGNATURE ALUMINIUM COMPOSITE DOOR?

Renowned for its perfect combination of light weight and high strength, and with a lifespan measured in decades rather than years, aluminium is the perfect material for entrance doors.





- 1 Strong & Secure**
Aluminium provides the perfect combination of light weight and high strength.
- 2 Long-lasting Performance**
With a lifespan measured in decades rather than years.
- 3 Energy Efficient**
Our Signature Doors provide enhanced performance and efficiency.
- 4 Low Maintenance**
There is no complicated maintenance, just a simple wipe down is all that's needed.
- 5 Weather Resistant**
Our doors are extremely weatherproof, with high levels of water and wind resistance.
- 6 The 'Greenest' Choice**
Aluminium is infinitely recyclable and our raw material is responsibly sourced.

Efficient & Sustainable

Make the Smart choice with our composite aluminium doors

- 
 Outstanding Security
- 
 Thermally Efficient
- 
 Weather Resistant
- 
 Noise Reduction
- 
 Resistant to UV Damage
- 
 Low Maintenance
- 
 Environmentally Friendly

DO YOU KNOW?

- 
75% of the aluminium ever produced is still in use today
- 
90% of energy used is saved by recycling aluminium
- 
100% of our aluminium is responsibly sourced
- 
 Aluminium can be **infinitely recycled**



We offer the most extensive GUARANTEES

So confident are we in the quality and performance of our **Signature Doors** that we provide an unrivalled set of **guarantees, covering everything from the door's paint finish, construction and security to its hardware and glazing.**

So, as well as a comprehensive 10 year manufacturing guarantee, every element of your new door is covered by a quality guarantee to provide you with complete peace of mind.



NO BOW GUARANTEE

No failures due to bowing or we'll fit a new door, **FREE!**



SECURITY GUARANTEE

If your home gets broken into via one of our 3* cylinders, we will pay £4000.



VIRTUALLY ZERO MAINTENANCE

Your door won't fade or discolour – and will never need to be repainted or varnished.



MADE IN BRITAIN

Our doors are designed for UK homes and made entirely in Britain



SIT BACK & RELAX

Choose a Signature door and relax, knowing you've chosen a beautiful and secure entrance door that will provide decades of high quality performance.

Make it yours

STYLE

The Signature Door collection combines elegance and style with outstanding performance and durability, with designs to enhance every style of home.

From ultra-modern to timeless traditional, there's a Signature Door design that will be perfect for your home. And you can tailor your door to suit your individual design and performance requirements, from our extensive range of colour, hardware and glazing options.



Harley
Page 10-11



Carnaby
Page 12-13



Lansdown
Page 14-15



Millbrook
Page 16-17



Portobello
Page 18-19



Portobello Half Glazed
Page 18-19



Portobello Full Glazed
Page 18-19



Broadfield
Page 20-21

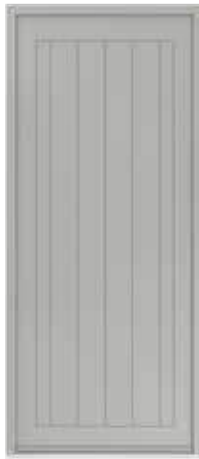

Abbey
Page 22-23



Abbey Square
Page 22-23



Abbey Rectangle
Page 22-23



Abbey Diamond
Page 22-23



Woodchester
Page 24-25



Baker
Page 26-27



Picton
Page 28-29



Grainger
Page 30-31

Our most popular **TEXTURED COLOURS**



Velour White
SEN001



Textured Black
KL15ST



Textured Anthracite
KL14ST



Platinum Grey
SEN016



Diamond Grey
SEN026



Silver Grey
SEN017



Steel Blue
SEN028



Sky Blue
SEN009



Sienna Brown
SEN004



Basque Red
SEN032



Sand
SEN003



Cotswold Green
CWD012



Wotton Olive
CWD010



Painswick Stone
CWD008



Cheltenham Stone
CWD005



Slad Stone
CWD015

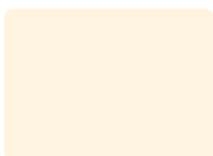

Bourton Cream
CWD002



Zinc Yellow
CTN006



Melon Yellow
CTN007



Mint Green
CTN003



Moss Green
CTN004



Pastel Blue
CTN002



Sapphire Blue
CTN001



Ruby Red
CTN005

These colours are for illustrative purposes only. We recommend requesting a painted aluminium sample from your supplier prior to placing your order.



Who is SMART?

With over 40 years' experience, Smart is the UK's leading supplier of aluminium window and door systems and part of the Made in Britain network.

With around 600 people working at our purpose-built 60,000m² manufacturing plant in the south west of England, we control the complete manufacturing process. From extruding aluminium profiles to applying a lustrous polyester powder coat paint finish, production, finishing and distribution all under one roof – guaranteeing quality.



Unlike other door manufacturers, we are extremely proud that the complete Signature Door collection is manufactured entirely in the UK.

From the initial design stage, through production and painting, to packaging and delivery, every element of our process takes place at our purpose-built factory in the southwest of England. And being UK based, not only are our doors made in Britain, but they are also designed specifically for the UK market, developed to complement quintessentially British house styles.



IMS623SSD.202504



BES668681



FM21582



EMS554307



OHS571955



ENMS634370

